

# Qucs

---

A Tutorial

Subcircuit and Verilog-A RF Circuit Simulation Models for  
Axial and Surface Mounted Resistors

Mike Brinson

---

Copyright © 2014 Mike Brinson, Centre for Communications Technology, London Metropolitan University, London, UK. <mbrin72043@yahoo.co.uk>

Permission is granted to copy, distribute and/or modify this document under the terms of the GNU Free Documentation License, Version 1.1 or any later version published by the Free Software Foundation. A copy of the license is included in the section entitled "GNU Free Documentation License".

# Introduction

Resistors are one of the fundamental building blocks in electronic circuit design. In most instances conventional resistor circuit simulation models are characterized by I/V characteristics specified by Ohm's law. In reality the impedance of RF resistors is frequency dependent, being determined by component physical properties, component manufacturing technology and how components are connected in a circuit. At low frequencies fixed resistors have a nominal value at room temperature and can be modelled accurately by Ohm's law. At RF frequencies the fact that a resistor acts more like an inductance or a capacitance can play a crucial role in determining whether or not a circuit operates as designed. Similarly, if a resistor is modelled as an ideal component at a frequency where it exhibits significant reactive properties then the resulting simulation data are likely to be incorrect. The subcircuit and Verilog-A compact resistor models introduced in this Qucs note are designed to give good performance from low frequencies to RF frequencies not greater than a few GHz.

## RF Resistor Models

The schematic symbol, I/V equation and parameters of the Qucs linear resistor model are shown in Figure 1. In contrast to this model Figure 2 illustrates the structure of a printed circuit board (PCB) mounted metal film (MF) axial RF resistor (a), its Qucs schematic symbol (b) and its equivalent circuit model (c). A thin film surface mounted (SMD) resistor can also be represented by the model shown in Figure 2 (c). At signal frequencies where the largest dimension of an axial or SMD resistor is less than approximately 20 times the smallest signal wavelength a resistor can be modelled by a lumped passive circuit consisting of a resistor  $R_s$  in series with a small inductance  $L_s$  with the combination shunted by parasitic capacitor  $C_p$ . In Figure 2  $R_s$  is the nominal value of a resistor at its parameter extraction temperature  $T_{nom}$ ,  $L_s$  represents the inductance associated with  $R_s$  where the value of  $L_s$  is largely determined by the trimming method employed during component manufacture to set the value of  $R_s$  to a specified tolerance. Similarly, capacitor  $C_p$  models a parasitic capacitance associated with  $R_s$  where the value of  $C_p$  is a function of the physical size of  $R_s$ . At RF frequencies it is important, for accurate operation, to add lead parasitic elements to the intrinsic equivalent circuit model shown within the red box draw in Figure 2. In Figure 2  $L_{lead}$  and  $C_{shunt}$  represent resistor series lead inductance and shunt capacitance to ground respectively. A typical set of model parameters for a  $51\ \Omega$  5 % MF axial resistor are (1)  $L_s=8\text{nH}$ ,  $C_p=1\text{pF}$ ,  $L_{lead}=1\text{nH}$  and  $C_{shunt}=0.1\text{pF}$ . Illustrated in Figure 3 is a basic S parameter test bench circuit for measuring the S parameters

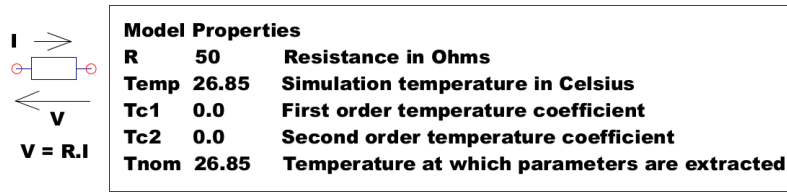

where  $R(\text{Temp}) = R(\text{Tnom}) \cdot (1 + \text{Tc1} \cdot (\text{Temp} - \text{Tnom}) + \text{Tc2} \cdot (\text{Temp} - \text{Tnom})^2)$

Figure 1: Qucs built-in resistor model.

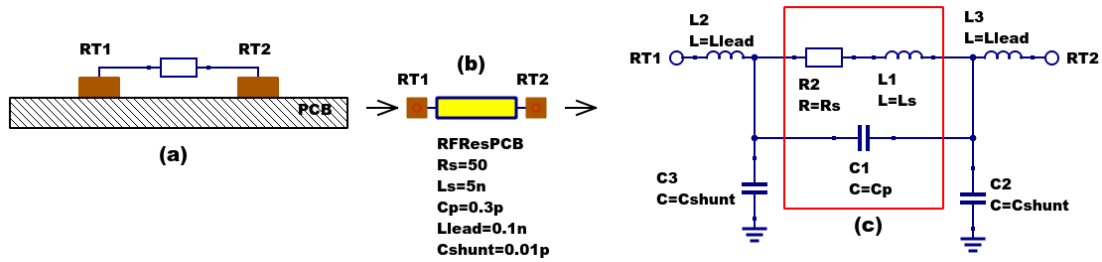

Figure 2: PCB mounted resistor: (a) axial component mounting, (b) Qucs symbol and (c) equivalent circuit model.

of an RF resistor over a frequency range 1 MHz to 1.3 GHz. This example also demonstrates how the real and imaginary parts of a resistor model impedance can be extracted from S parameter simulation data. The graphs in Figure 3 clearly demonstrate that the impedance of the typical MF RF resistor described in previous text and modelled by the equivalent circuit shown in Figure 2 is a strong function of frequency at higher frequencies in the band 1 MHz to 1.3 GHz.

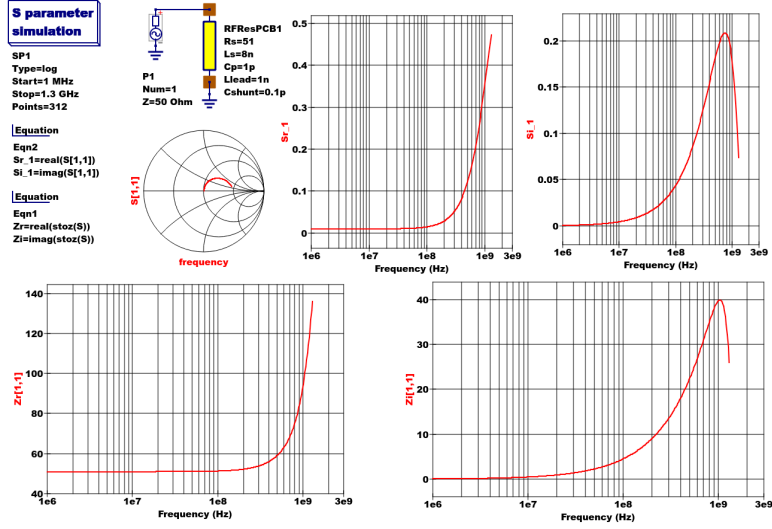

Figure 3: Qucs S parameter simulation test circuit and plotted output data for a MF axial resistor:  $R_s=51\Omega$ ,  $L_s=8\text{nH}$ ,  $C_p=1\text{pF}$ ,  $L_{lead}=1\text{nH}$  and  $C_{shunt}=0.1\text{pF}$ .

## Analysis of the RF resistor model

A component level version of the proposed RF resistor model is shown in Figure 4, where

$$Z1 = j \cdot \omega \cdot L_{lead} \quad (1)$$

$$Z2 = \frac{R_s + j \cdot \omega \cdot L_s \cdot (1 - \omega^2 \cdot C_p \cdot L_s) - j \cdot \omega \cdot C_p \cdot R_s^2}{(1 - \omega^2 \cdot C_p \cdot L_s)^2 + (\omega \cdot C_p \cdot R_s)^2} \quad (2)$$

$$Z3 = \frac{j \cdot \omega \cdot L_{lead}}{(1 - \omega^2 \cdot L_{lead} \cdot C_{shunt})} \quad (3)$$

$$Z_{series} = Z1 + Z2 = R_{series} + j \cdot X_{series} \quad (4)$$

$$Z_b = Z_{series} || X_{Cshunt} = \frac{Z_{series}}{(1 + j \cdot \omega \cdot C_{shunt} \cdot Z_{series})} = Z_{BR} + j \cdot \omega \cdot Z_{BI}, \quad (5)$$

$$Z = j \cdot \omega \cdot L_{lead} + Z_b = Z_R + j \cdot \omega \cdot Z_I. \quad (6)$$

Figure 5 illustrates how a set of theoretical equations can be converted into Qucs equations for model simulation and post simulation data processing. In this example Qucs equation *Eqn1* holds values for RF resistor model parameters and Qucs equation *Eqn2* lists the model equations introduced at the start of this section. Figure 5 also gives a set of cartesian graphs of post simulation output data which

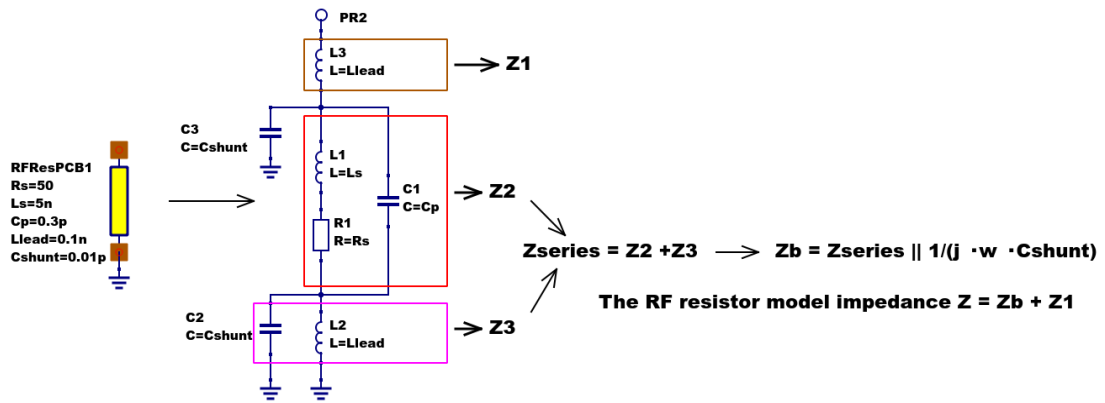

Figure 4: RF resistor model rotated through 90 degrees and connected with one terminal grounded, similar to the test circuit in Figure 3. Sections of the model are shown grouped for calculation of the model impedance  $Z$ .

illustrate how  $Z_R$  and  $Z_I$ , and other calculated items, vary with frequency over the range 1 MHz to 1.3 GHz.

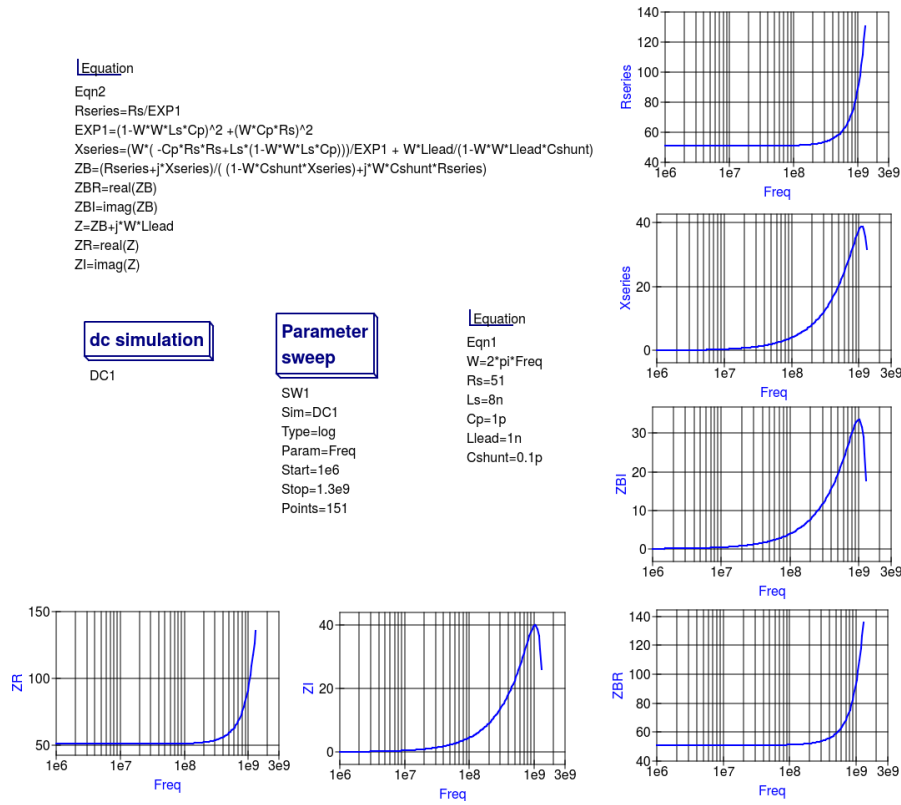

Figure 5: Theoretical analysis of RF resistance impedance  $Z$  using Qucs post processing facilities: note a dummy simulation icon, in this example DC simulation, is required to force Qucs to complete the analysis calculations.

## Direct measurement of RF resistor impedance using a simulated impedance meter

A simple impedance meter for measuring the real and imaginary components of component and circuit impedance, using small signal AC simulation, is shown in Figure 6. The impedance measuring technique uses a 1 Amp AC constant current source applied to one terminal of a two port electrical network. The second terminal is grounded. A parallel high resistance resistor ( $1E9 \Omega$  in Figure 6) shunts the network under measurement to ensure that there is always a direct current path to ground as required by the Qucs simulator during the calculation of simulation results. If required the 1 Amp AC source can be set at a lower value. In such cases the value of  $VRes$  must also be scaled to give the network impedance.

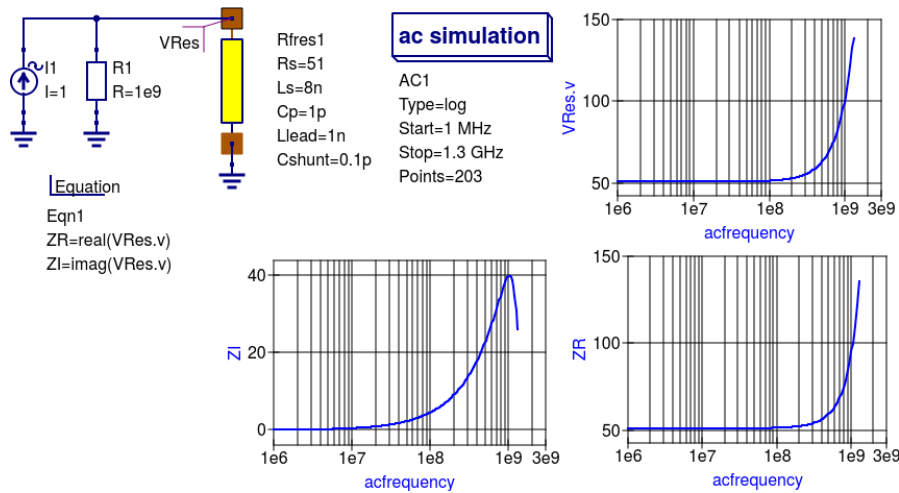

Figure 6: A simple Qucs test circuit for demonstrating the use of an AC constant current source to measure electrical network impedance.

## Extraction of RF resistor data from measured S parameters

In the past the cost of Vector Network Analyser systems for measuring S parameters has been prohibitively expensive for individual engineers to purchase. However, this scene is changing with the introduction of low cost systems like the DGSAQ Vector Network Analyser (VNWA) <sup>1</sup>. This instrument operates over a frequency band width of 1.3 GHz, providing a range of useful functions with highest accuracy at frequencies up to 500 MHz. This form of VNWA is particularly suited to Radio Amateur requirements and Qucs users interested in RF circuit analysis and design. Such equipment is ideal for measuring RF circuit S parameters and providing measured data for subcircuit and Verilog-A compact device model parameter extraction. Shown in Figure 7 is a graph of measured S parameter data for a nominal 47  $\Omega$  resistor <sup>2</sup>. As well as displaying, and printing, measured data the DGSAQ Vector Network Analyser software can output data tabulated in Touchstone<sup>®</sup> “SnP” <sup>3</sup>file format. These files can be read by Qucs and their contents attached to an S parameter file icon for inclusion in circuit

<sup>1</sup>DG8SAQ VNWA 3 & 3E- Vector Network Analysers, SDR Kits Limited, Grangeside Business Centre, 129 Devizes Road, Trowbridge, Wilts BA14-7sZ, United Kingdom, 2014. [www.SDR-Kits.net](http://www.SDR-Kits.net).

<sup>2</sup>See DG8SAQ VNWA 3 & 3E- Vector Network Analysers- Getting Started Manual for Windows 7, Vista and Windows XP.

<sup>3</sup> [http://en.wikipedia.org/wiki/Touchstone\\_filedata](http://en.wikipedia.org/wiki/Touchstone_filedata)

schematic diagrams. Figure 8 shows this process as part of an RF resistor model parameter extraction technique involving DGSAQ VNWA measured S parameter data and Qucs simulated S parameter data. The brown “Test circuits” box shows test circuits for firstly reading and processing the DGSAQ VNWA measured data listed in file mike3.s1p, and for secondly generating simulated S parameter data for an RF resistor specified by parameters  $L_s=L$ ,  $C_p=C$ ,  $L_{lead}=LL$ ,  $C_{shunt}=0.08$  pF, and  $R_s=47.3 \Omega$ . Presented in Figure 9 are the Qucs Optimization controls” which are used to set the range of L, C and LL values that optimizer ASCO will select from to obtain the best fit between the measured and simulated S parameter data. Note in this parameter extraction system that S[1,1] refers to measured S parameter data and S[2,2] to simulated S parameter data. Two least squares cost functions called  $CF1$  and  $CF2$  are used as targets in the minimisation process. Values for  $CF1$  and  $CF2$  can be found in the red box called “Simulation Controls“. In this parameter extraction example the least squares cost function  $CF1$  is employed to minimize the square of the difference between the real values of the S parameters and least squares cost function  $CF2$  is employed to minimize the square of the difference between the imaginary values of the S parameters. Qucs post-simulation processing is also used to extract values for the real and imaginary components of the RF resistor impedance. Both the S parameter data and the impedance data are displayed as graphs in Figure 8. Notice in this example the SPICE optimizer ASCO is used to find the values of  $L$ ,  $C$  and  $LL$  which minimize  $CF1$  and  $CF2$ . Also note that  $R_s$  and  $C_{shunt}$  are held at fixed values during optimization. In the case of  $R_s$  its nominal value can be found from DC or low frequency AC measurements. Similarly the value selected for  $C_{shunt}$  has been chosen to give a very small but representative value of the parasitic shunt capacitance.. After optimization finishes the minimized values of  $L$ ,  $C$  and  $LL$  are given in the initial value column of the Qucs optimization Variables list, see Figure 9. For the  $47 \Omega$  resistor the post-minimization RF resistor model parameters are  $R_s=47.3 \Omega$ ,  $L_s=10.43$  nH,  $C_p=0.69$  pF,  $L_{lead}=1.46$  nH and  $C_{shunt}=0.08$  pF. The theoretical simulation data illustrated in Figure 10 shows good agreement with the measured and the optimized simulation data.



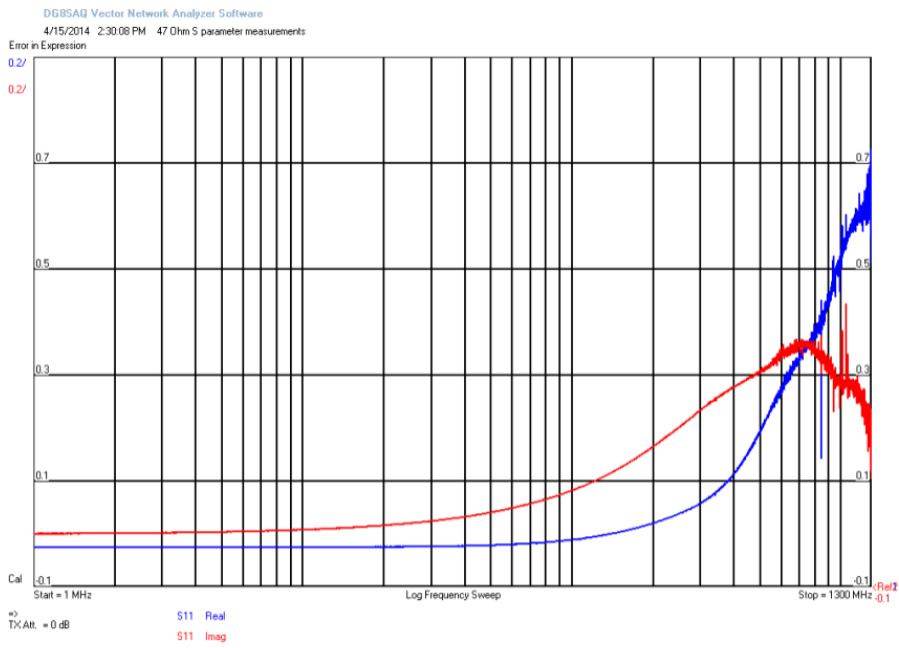

Figure 7: DGSAQ Vector Network Analyser S parameter measurements for a 47  $\Omega$  axial RF resistor.

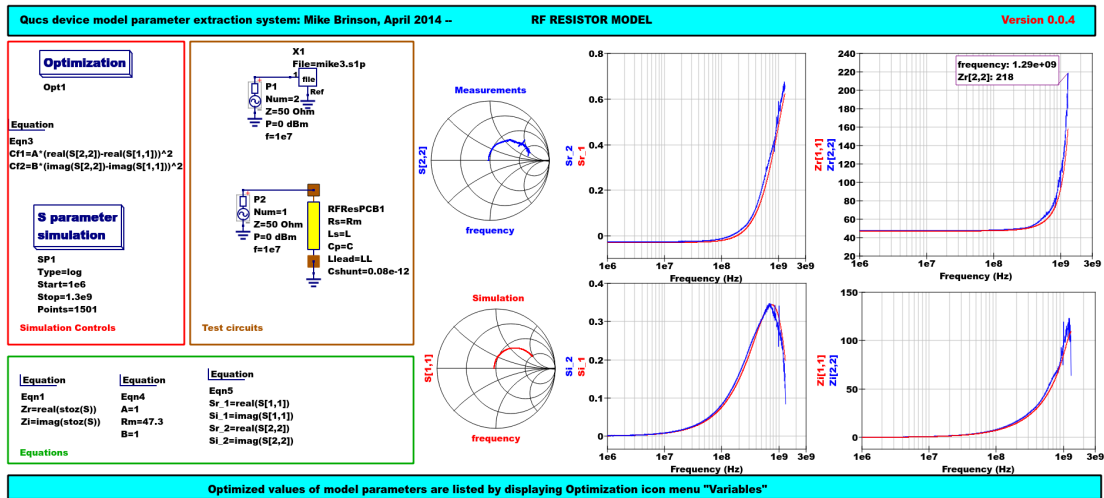

Figure 8: Qucs device model parameter extraction system applied to a nominal  $47\ \Omega$  resistor represented by the subcircuit model illustrated in Figure 2 (c). Fixed model parameter values:  $R_s=R_m=47.3\ \Omega$ ,  $C_{Shunt}=0.08\text{pF}$ ; Optimised values:  $L_s=L=10.43\text{nH}$ ,  $L_{lead}=LL=1.47\text{nH}$ ,  $C_p=C=0.69\text{pF}$ . To reduce simulation time the ASCO cost variance was set to  $1e-3$ . The ASCO method was set to DE/best/1/exp.

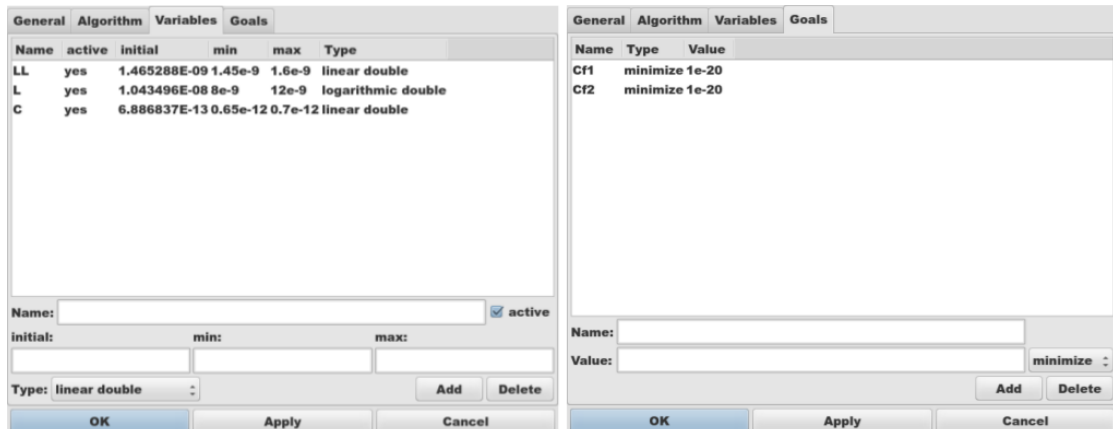

Figure 9: Qucs Minimization Icon drop down menus: left "Variables" and right "Goals".

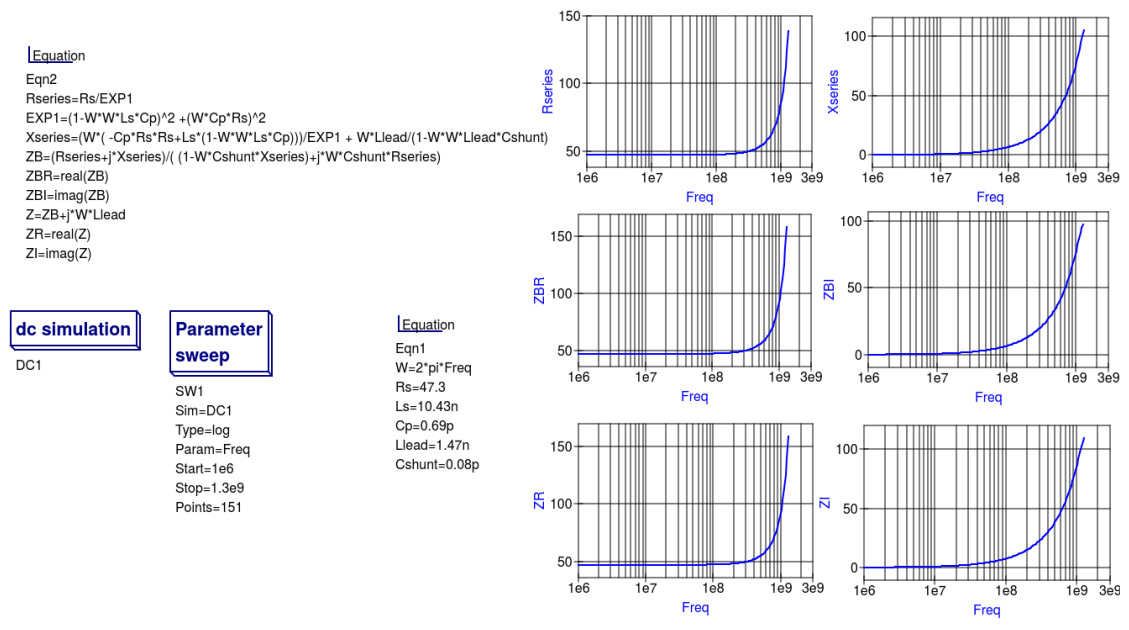

Figure 10: Qucs simulation of nominal 47 Ω resistor based on theoretical analysis.

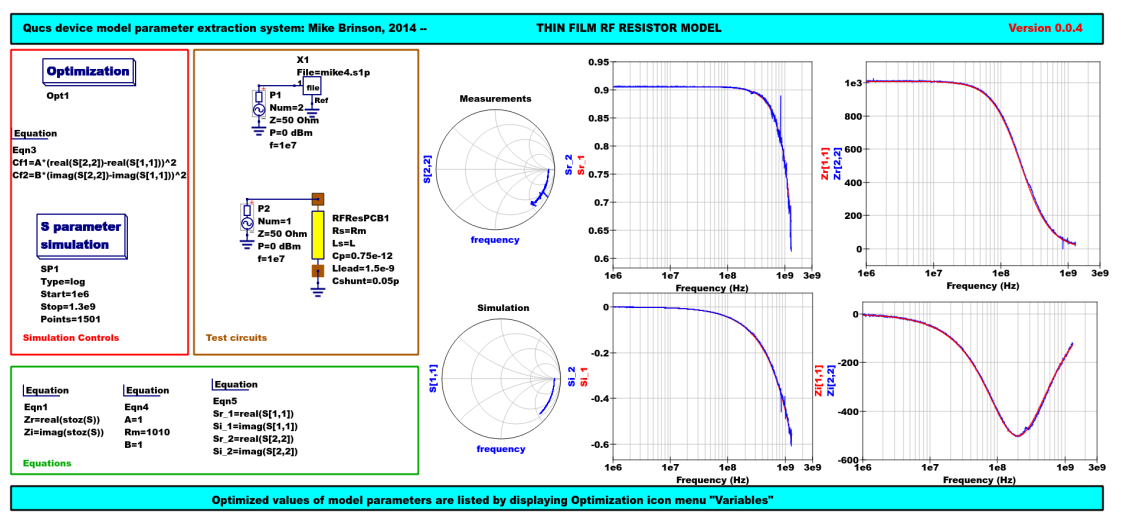

Figure 11: Qucs device model parameter extraction system applied to a nominal 1000 Ω resistor represented by the subcircuit model illustrated in Figure 2 (c).

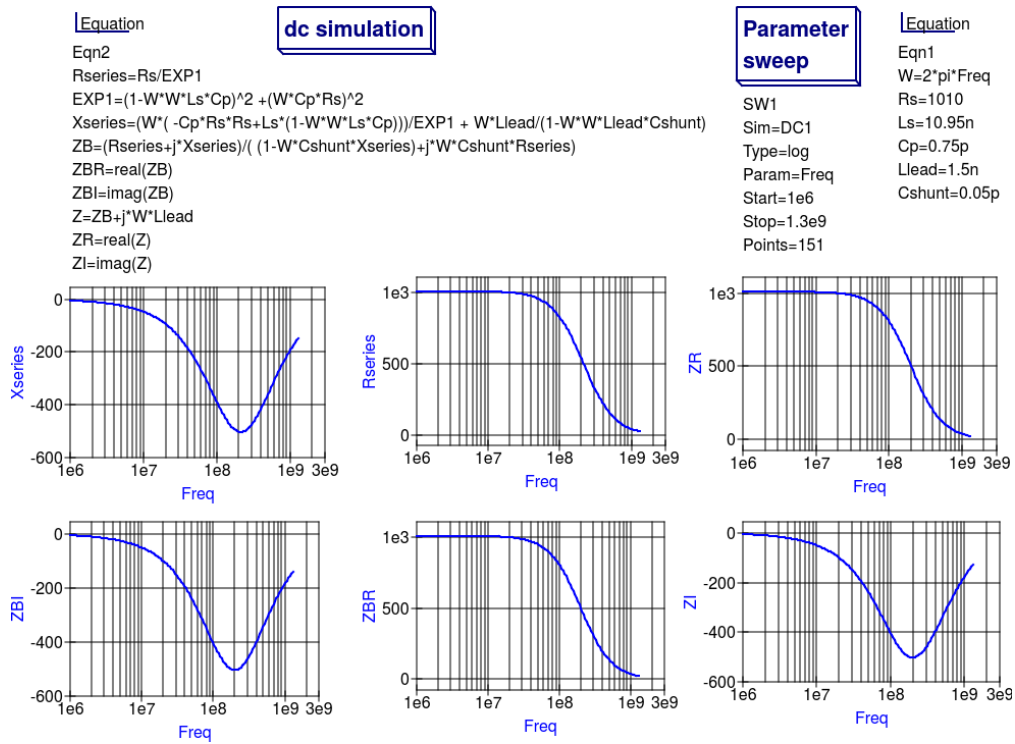

Figure 12: Qucs simulation of nominal 1000  $\Omega$  resistor based on theoretical analysis.

# Extraction of RF resistor parameters from measured S data for a nominal 1000 $\Omega$ axial resistor

At low resistance values the impedance of an RF resistor becomes inductive as the signal frequency is increased. This is due to the fact that the inductance  $L_s$  contribution dominates any reactance effects by  $C_p$ ,  $L_{lead}$  and  $C_{shunt}$ . However, as  $R_s$  is increased above a few hundred Ohm's the reverse becomes true with reactive effects dominated by contributions from  $C_p$ . Figures 11 and 12 demonstrate the dominance of  $C_p$  reactive effects at low to mid-range frequencies.

# One more example: extraction of RF resistor parameters from measured S data for a nominal 100 $\Omega$ SMD resistor

Figure 13 is included in this Qucs note purely for comparison purposes. SMD resistors are in general physically very small when compared to axial resistors. This results in lower values for the inductive and capacitive parasitics which in turn ensures that the high frequency performance of SMD resistors is much improved.

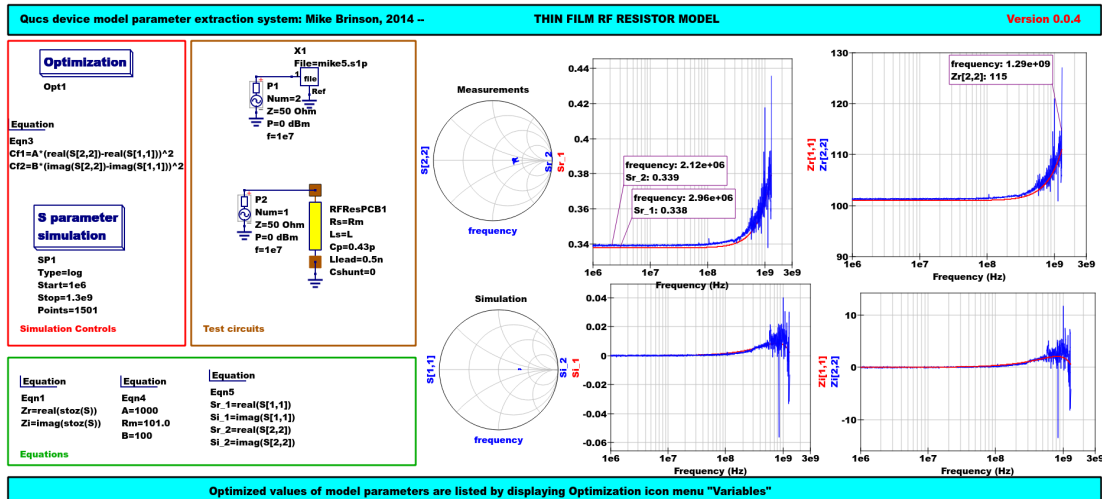

Figure 13: Qucs device model parameter extraction system applied to a nominal 100  $\Omega$  SMD resistor represented by the subcircuit model illustrated in Figure 2 (c).

## A Verilog-A RF resistor model

Listed below is an example Verilog-A code model for the RF resistor model introduced in Figure 2 (c). Due to the limitations of the Verilog-A language subset provided by version 2.3.0 of the "Analogue Device Model Synthesizer" (ADMS)<sup>4</sup> inductors  $L_s$  and  $L_{lead}$  are modelled by gyrators and capacitors with values identical to  $L_s$  or  $L_{lead}$ .

```
// Verilog-A module statement.
//
// RFresPCB.va RF resistor (Thin film resistor, axial type, PCB mounting)
//
// This is free software; you can redistribute it and/or modify
// it under the terms of the GNU General Public License as published by
// the Free Software Foundation; either version 2, or (at your option)
// any later version.
//
// Copyright (C), Mike Brinson, mbrin72043@yahoo.co.uk, April 2014.
//
`include "disciplines.vams"
`include "constants.vams"
// Verilog-A module statement.
module RFresPCB(RT1, RT2);
  inout RT1, RT2;          // Module external interface nodes.
  electrical RT1, RT2;
  electrical n1, n2, n3, nx, ny, nz;      // Internal nodes.
  `define attr(txt) (*txt*)
  parameter real Rs = 50          from [1e-20 : inf)
    `attr(info="RF resistance" unit="Ohm's");
  parameter real Cp = 0.3e-12    from [0 : inf)
    `attr(info="Resistor shunt capacitance" unit="F");
  parameter real Ls = 8.5e-9     from [1e-20 : inf)
    `attr(info="Series inductance" unit="H");
  parameter real Llead = 0.1e-9  from [1e-20 : inf)
    `attr(info="Parasitic lead inductance" unit="H");
  parameter real Cshunt = 1e-10   from [1e-20 : inf)
    `attr(info="Parasitic shunt capacitance" unit="F");
  parameter real Tc1 = 0.0        from [-100 : 100]
    `attr(info="First order temperature coefficient" unit="Ohm/Celsius");
  parameter real Tc2 = 0.0        from [-100 : 100]
```

<sup>4</sup> <http://sourceforge.net/projects/mot-adms/>

```

    'attr(info="Second order temperature coefficient" unit="(Ohm/Celsius)^2");
parameter real Tnom = 26.85 from [-273.15 : 300]
    'attr(info="Parameter extraction temperature" unit="Celsius");
parameter real Temp = 26.85 from [-273.15 : 300]
    'attr(info="Simulation temperature" unit="Celsius");
branch (RT1, n1) bRT1n1; // Branch statements
branch (n1, n2) bn1n2;
branch (n1, n3) bn1n3;
branch (n2, n3) bn2n3;
branch (n3, RT2) bn3RT2;
real Rst, FourKT, n, Tdiff, Rn;
analog begin // Start of analog code
@(initial_model)
begin
    Tdiff = Temp-Tnom; FourKT =4.0*'P_K*Temp;
    Rst = Rs*(1.0+Tc1*Tdiff+Tc2*Tdiff*Tdiff); Rn = FourKT/Rst;
end
I(n1) <+ ddt(Cshunt*V(n1)); I(bn1n2) <+ V(bn1n2)/Rst;
I(bn1n3) <+ ddt(Cp*V(bn1n3)); I(n3) <+ ddt(Cshunt*V(n3));
I(bRT1n1) <+ -V(nx); I(nx) <+ V(bRT1n1); // Llead
I(nx) <+ ddt(Llead*V(nx));
I(bn2n3) <+ -V(ny); I(ny) <+ V(bn2n3); // Ls
I(ny) <+ ddt(Ls*V(ny));
I(bn3RT2) <+ -V(nz); I(nz) <+ V(bn3RT2); // Llead
I(nz) <+ ddt(Llead*V(nz));
I(bn1n2) <+ white_noise(Rn, "thermal"); // Noise contribution
end // End of analog code
endmodule

```

# Module RFresPCB

## Input Variables

Input Variables: instance=0 (bold) and model=9

name	description	default
<b>Rs</b>	RF resistance	50
<b>Cp</b>	Resistor shunt capacitance	0.3e-12
<b>Ls</b>	Series inductance	8.5e-9
<b>Llead</b>	Parasitic lead inductance	0.1e-9
<b>Cshunt</b>	Parasitic shunt capacitance	1e-10
<b>Tc1</b>	First order temperature coefficient	0.0
<b>Tc2</b>	Second order temperature coefficient	0.0
<b>Tnom</b>	Parameter extraction temperature	26.85
<b>Temp</b>	Simulation temperature	26.85

## Output Variables

Output Variables: instance=0  
(bold) and model=0  
(red-underlined>: temperature  
dependent)

name	description	dependencies
------	-------------	--------------

## Nature/Discipline Definition

Nature			
name	access	abstol	units
Current	I	1e-12	A
Charge	Q	1e-14	coul
Voltage	V	1e-6	V
Flux	Phi	1e-9	Wb
Magneto Motive Force	MMF	1e-12	A*turn
Temperature	Temp	1e-4	K
Power	Pwr	1e-9	W
Position	Pos	1e-6	m
Velocity	Vel	1e-6	m/s
Acceleration	Acc	1e-6	m/s^2
Impulse	Imp	1e-6	m/s^3
Force	F	1e-6	N
Angle	Theta	1e-6	rads
Angular Velocity	Omega	1e-6	rads/s
Angular Acceleration	Alpha	1e-6	rads/s^2
Angular Force	Tau	1e-6	N*m

Discipline		
name	potential	flow
logic		
electrical	Voltage	Current
voltage	Voltage	
current	Current	
magnetic	Magneto Motive Force	Flux
thermal	Temperature	Power
kinematic	Position	Force
kinematic_v	Velocity	Force
rotational	Angle	Angular Force
rotational_omega	Angular Velocity	Angular Force

## Model Equations

Notations used:

- green: input parameter
- bar over: variable never used
- bar under: temperature dependent variable
- red: voltage dependent variable

Initial Model

$$Tdiff = (Temp - Tnom);$$

$$FourKT = ((4.0 \cdot 1.3806503e-23) \cdot Temp);$$

$$Rst = (Rs \cdot ((1.0 + (Tc1 \cdot Tdiff) + ((Tc2 \cdot Tdiff) \cdot Tdiff)));$$

$$Rn = \frac{FourKT}{Rst};$$

----- end of Initial Model

$$I(n1, n1) <+ ddt((Cshunt \cdot V(n1, n1)));$$

$$I(n1, n1) <+ \frac{V(n1, n1)}{Rst};$$

$$I(n1, n1) <+ ddt((Cp \cdot V(n1, n1)));$$

$$I(n3, n3) <+ ddt((Cshunt \cdot V(n3, n3)));$$

$$I(RT1, RT1) <+ (-V(nx, nx));$$

$$I(nx, nx) <+ V(RT1, RT1);$$

$$I(nx, nx) <+ ddt((Llead \cdot V(nx, nx)));$$

$$I(n2, n2) <+ (-V(ny, ny));$$

$$I(ny, ny) <+ V(n2, n2);$$

$$I(ny, ny) <+ ddt((Ls \cdot V(ny, ny)));$$

$$I(n3, n3) <+ (-V(nz, nz));$$

$$I(nz, nz) <+ V(n3, n3);$$

$$I(nz, nz) <+ ddt((Llead \cdot V(nz, nz)));$$

$$I(n1, n1) <+ white_noise(Rn, "thermal");$$

Figure 14: Details of the proposed RF resistor model: equations, variables and other data.



# Extraction of Verilog-A RF resistor model parameters from measured S data for a 100 $\Omega$ axial resistor

This example demonstrates the use of ASCO for extracting Verilog-A model parameters from measured S parameter data. ASCO optimization yields a figure of 4nH for  $L$  in the model shown in Figure 2 (c). Other model parameter values are given with the test circuit, see Figure 15.

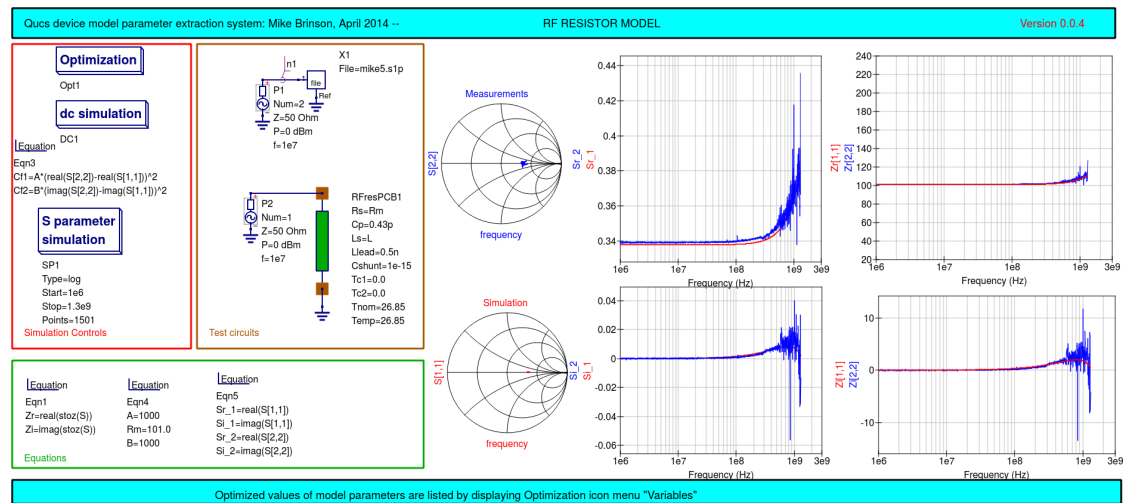

Figure 15: Verilog-A models parameter data extraction for a 100  $\Omega$  axial thin film resistor. Fixed model parameter values:  $R_s=R_m=101\Omega$ ,  $C_{Shunt}=1e-15$ ,  $L_{lead}=L=0.5nH$ ,  $C_p=C=0.43pF$ ; Optimised values:  $L_s=L=3.99nH$ . To reduce simulation time the ASCO cost variance was set to  $1e-3$ . The ASCO method was set to DE/best/1/exp.

## End Notes

This brief Qucs note outlines the fundamental properties of subcircuit and verilog-A compact component models for RF resistors. The use of optimization for the extraction of subcircuit and Verilog-A compact model parameters from measured S parameters is also demonstrated. The presented techniques form part of the simulation and device modelling capabilities available with the latest Qucs release 5.

<sup>5</sup>Qucs release 1.0.0 rc1, or greater.